

BRAVE ZA METALNA VRATA

TITAN

BRAVE ZA METALNA VRATA TITAN

- brave su lijeve ili desne, osim brava s valjkom i brava s podizačem koje su univerzalne (uvlačenje jezička za kvaku i njegovo okretanje)
- dvije varijante pakiranja: u kompletu sa cilindrom u ložnici 27/27; bez prihvatnika i cilindar u ložnici, tzv. industrijsko pakiranje, što je navedeno u nazivu robe

šifra	opis proizvoda	artikl	jedinica mjere
111003	LIJEVA	822/25	KOM
111017	DESNA	822/25 D	KOM
111022	INDUSTRIJSKO PAKIRANJE LIJEVA	822/25 INDL	KOM
111025	INDUSTRIJSKO PAKIRANJE DESNA	822/25 INDD	KOM

BRAVA ZA CILINDER

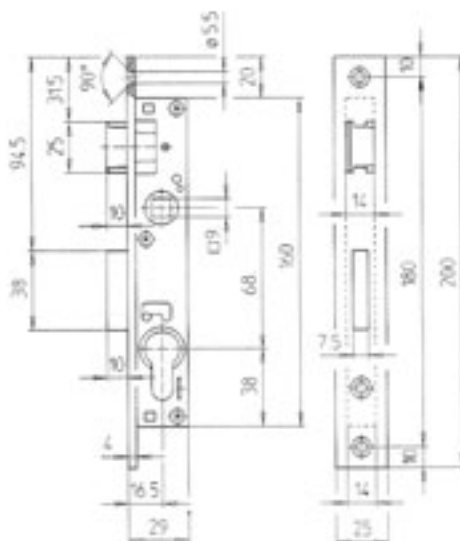

BRAVE ZA METALNA VRATA

TITAN

BRAVA ZA CILINDER S PODIZAČEM



šifra	opis proizvoda	artikl	jedinica mjere
111006	UNIVERZALNA A=25	831/25	KOM
111007	UNIVERZALNA A=30	831/30	KOM
111008	UNIVERZALNA A=35	831/35	KOM
111009	UNIVERZALNA A=40	831/40	KOM

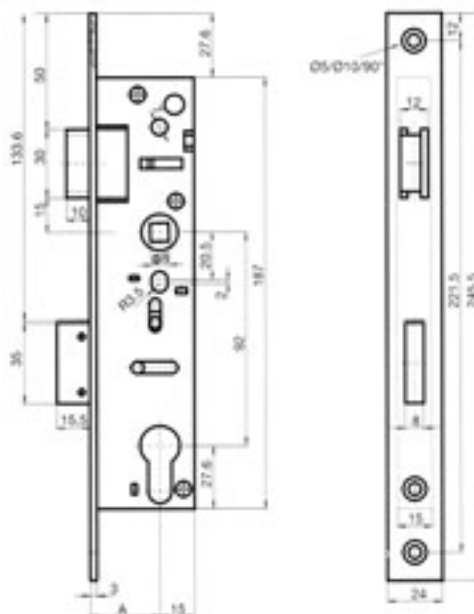

BRAVA ZA CILINDER S VALJKOM



šifra	opis proizvoda	artikl	jedinica mjere
111010	UNIVERZALNA	821/25	KOM
111012	INDUSTRIJSKO PAKIRANJE	821/25 IND	KOM

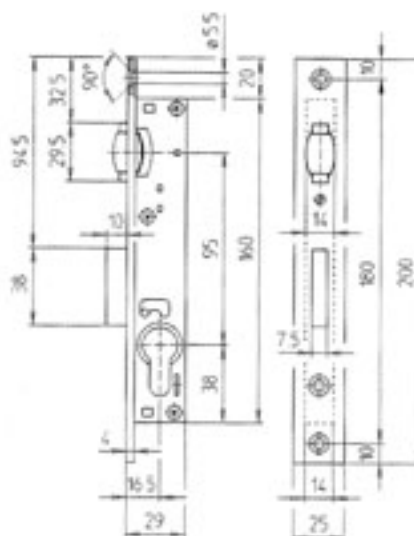

BRAVE ZA METALNA VRATA

TITAN

BRAVA ZA CILINDER S VALJKOM



šifra	opis proizvoda	artikl	jedinica mjere
111011	UNIVERZALNA	821/40	KOM
111023	INDUSTRIJSKO PAKIRANJE	821/40 IND	KOM

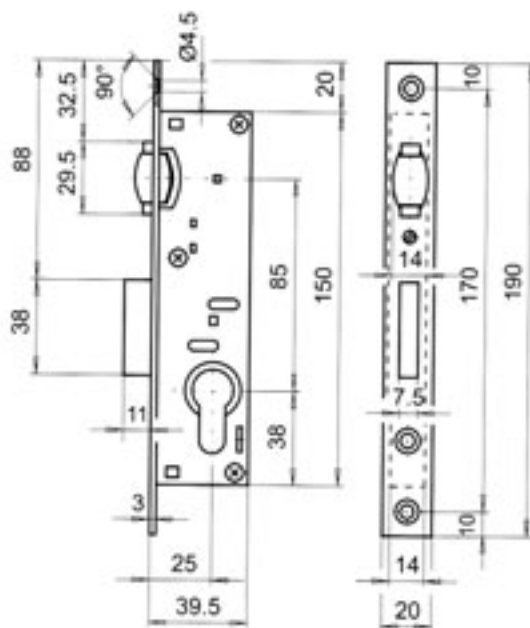

BRAVA ZA CILINDER BEZ ZASUNA ZA KVAKU



šifra	opis proizvoda	artikl	jedinica mjere
111002	UNIVERZALNA	823	KOM

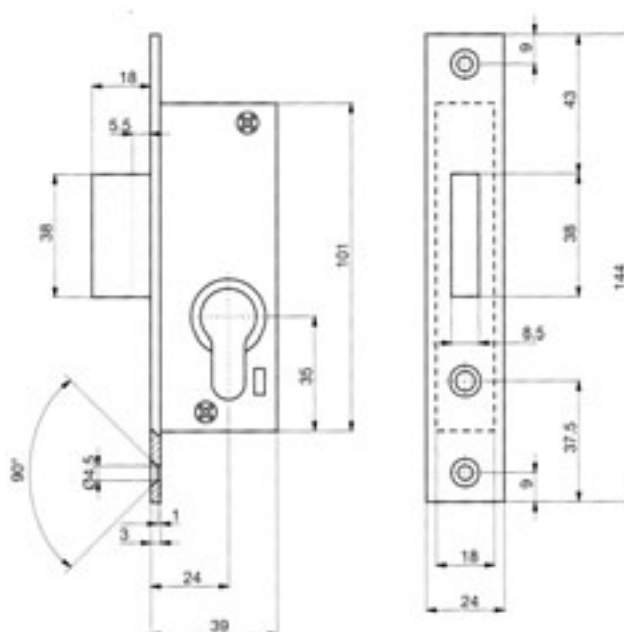

BRAVE ZA METALNA VRATA

TITAN

BRAVA PRIBITNA ZA CILINDER



šifra	opis proizvoda	artikl	jedinica mjere
111015	INDUSTRIJSKO PAKIRANJE LIJEVA	820 L	KOM
111014	INDUSTRIJSKO PAKIRANJE DESNA	820 D	KOM

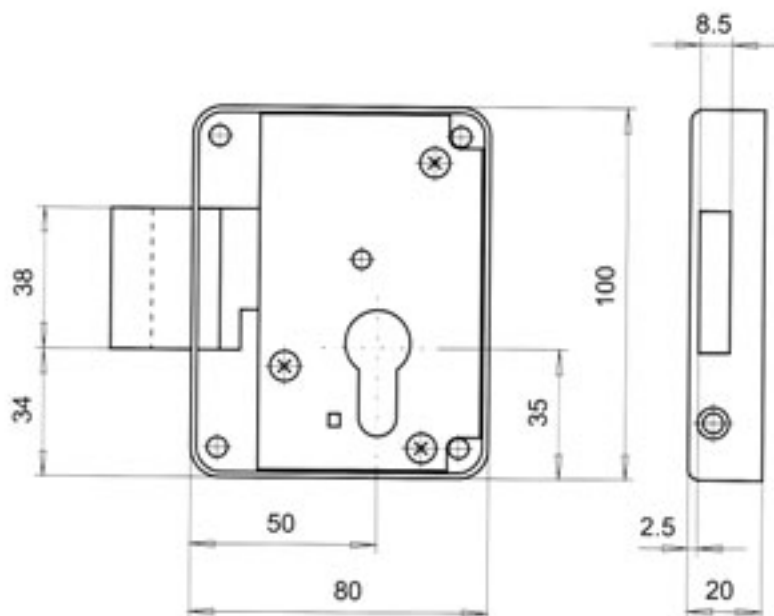

BRAVE ZA METALNA VRATA

ŽEČE

BRAVE ZA METALNA VRATA ŽEČE

- finalna obrada: čeona ploča od brušenog aluminija, ostali dijelovi svijetlo pocinčani
- valjkasti jezičak od mesinga regulira se vijkom u čeonoj ploči
- jednostruki hod zasuna
- čeona ploča 205 x 25 mm, otvori za kvaku 9 x 9 mm
- pakirane bez prihvatnika i cilindar uložaka

BRAVA ZA CILINDER



šifra	opis proizvoda	artikl	jedinica mjere
114001	LIJEVA	17.40	KOM
114004	DESNA	17.40 D	KOM

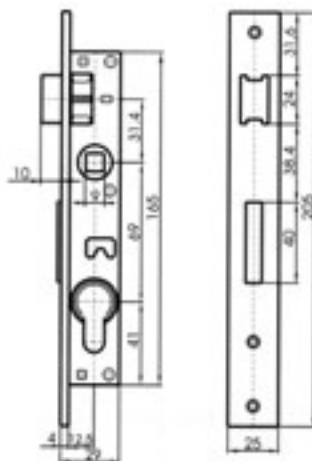

BRAVA ZA CILINDER



šifra	opis proizvoda	artikl	jedinica mjere
114002	LIJEVA	17.47	KOM
114005	DESNA	17.47 D	KOM

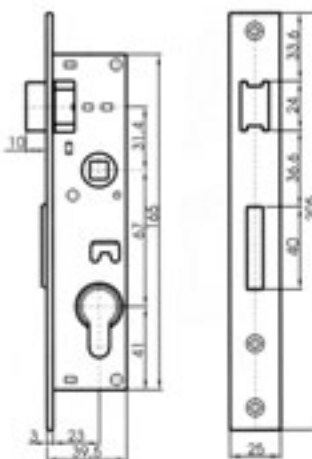

BRAVE ZA METALNA VRATA

ŽEČE

BRAVA ZA CILINDER S PODIZAČEM



šifra	opis proizvoda	artikl	jedinica mjere
114003	UNIVERZALNA	17.43	KOM

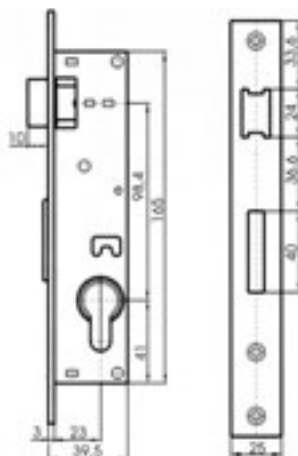

BRAVA ZA CILINDER S VALJKOM



šifra	opis proizvoda	artikl	jedinica mjere
114006	UNIVERZALNA	17.41	KOM

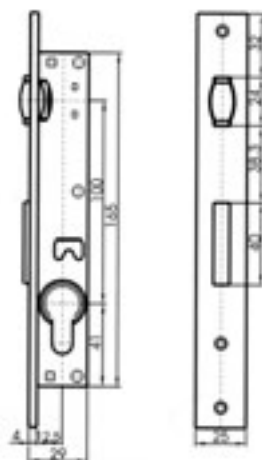

BRAVA ZA CILINDER S VALJKOM



šifra	opis proizvoda	artikl	jedinica mjere
114007	UNIVERZALNA	17.46	KOM

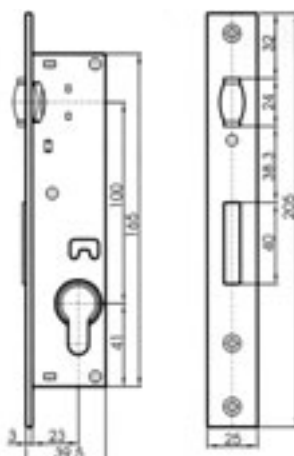

BRAVE ZA METALNA VRATA

BANE SEKULIĆ

BRAVE ZA METALNA VRATA BANE SEKULIĆ

- namijenjeno zatvaranju metalnih vrata izrađenih od užih profila
- trn za kvaku = 8 x 8 mm
- pakirane bez prihvatnika i cilindar uložaka
- dubine 25 ili 36 mm

BRAVA ZA CILINDER



šifra	opis proizvoda	artikl	jedinica mjere
112003	25 mm LIJEVA	9.SKK/25	KOM
112011	25 mm DESNA	9.SKK/25-D	KOM

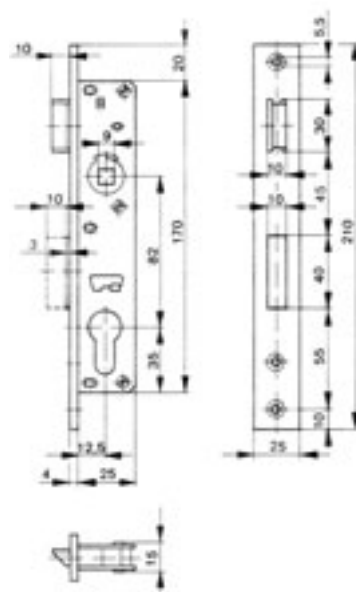

BRAVA ZA CILINDER



šifra	opis proizvoda	artikl	jedinica mjere
112004	36 mm LIJEVA	9.SKK/36	KOM
112015	36 mm DESNA	9.SKK/36-D	KOM

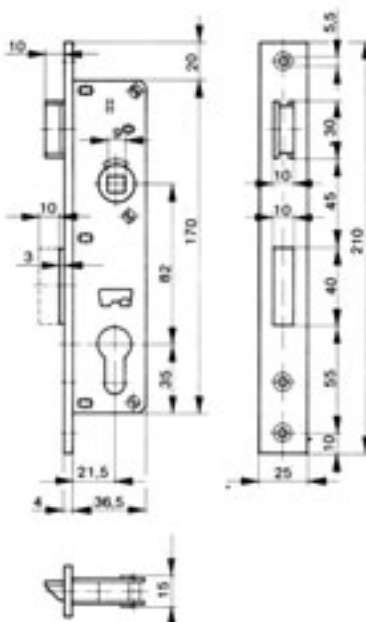

BRAVE ZA METALNA VRATA

BANE SEKULIĆ

BRAVA ZA CILINDER S PODIZAČEM



šifra	opis proizvoda	artikl	jedinica mjere
112012	25 mm	9.SKK/25 P	KOM

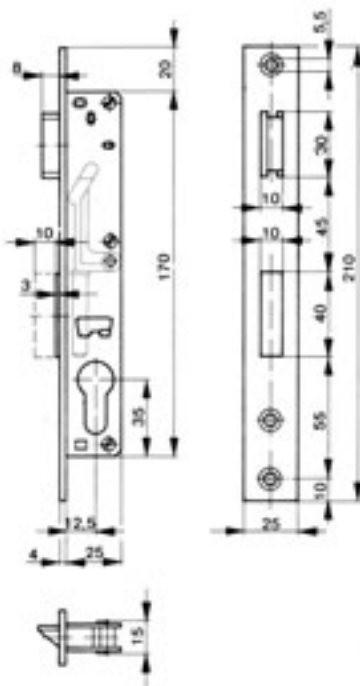

BRAVA ZA CILINDER S PODIZAČEM



šifra	opis proizvoda	artikl	jedinica mjere
112014	36 mm LIJEVA	9.SKK/36 P-L	KOM
112013	36 mm DESNA	9.SKK/36 P	KOM

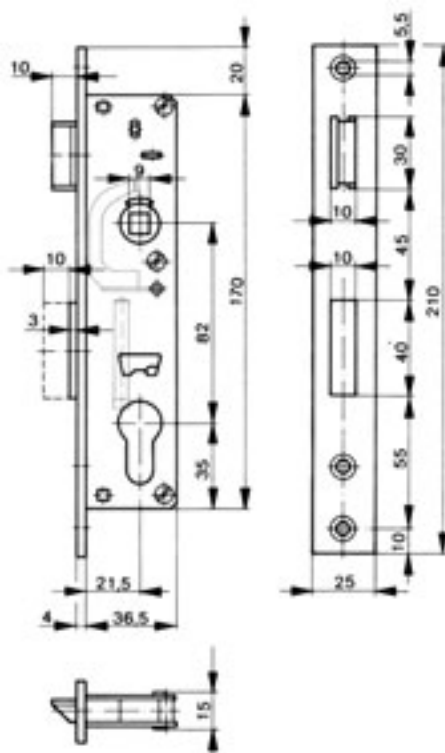

BRAVE ZA METALNA VRATA

BANE SEKULIĆ

BRAVA ZA CILINDER S VALJKOM



Sifra	opis proizvoda	artikl	jedinica mjere
112005	25 mm	9.SKZ/25	KOM

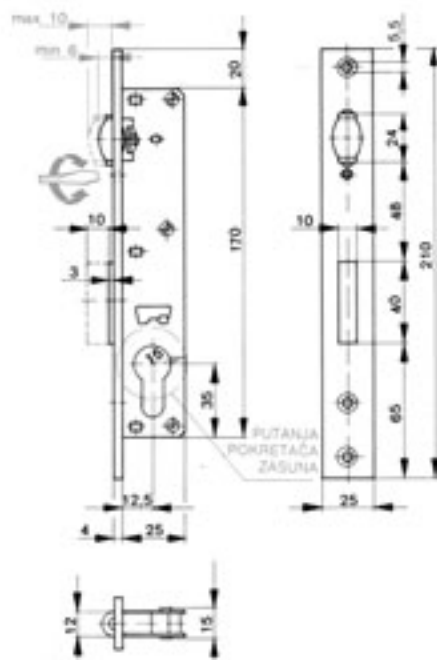

BRAVA ZA CILINDER S VALJKOM



Sifra	opis proizvoda	artikl	jedinica mjere
112006	36 mm	9.SKZ/36	KOM

